



























Ташев-Галвинг
www.tashev-galving.com

Technical Symbols

-  Weight (total)
-  Length (total)
-  Length (total)
-  Length (total)
-  Length of blade
-  Blade / Cutting edge width
-  Blade thickness
-  Width across flats (Nominal Width)
-  Width across flats (Nominal Width)

-  Width across flats (Nominal Width)
-  Screw dimension (type of thread)
-  Drive types
-  Slotted
-  Cross-head PH
-  Cross-head Pozi PZ
-  Hexagon internal
-  Internal hexagon with tamper proof hole

-  Internal-TORX®
-  Internal TORX® with pilot
-  External TORX®
-  Internal serrations XZN
-  TORX PLUS®
-  Conformity with EU guidelines
-  VDE Test Symbol (Tools)
-  new
-  Catalogue page





Screwdrivers



Service / Features 338

3C-Screwdriver  339 – 342

3C-Screwdriver with striking cap  343

Screwdriver with wooden handle  344

Electronic screwdriver  345 – 346

Hexagon Allen Keys  346 – 356

Voltage tester  357

Various  357



Ташев-Галвинг ООД
www.tashev-galving.com

 **FOR TORQUE SCREWDRIVERS** 296 - 300 



see product group Torque Tools

 **1500 ES/CT** 101 · 109 



 **VDE** 538 - 539 







powerful - unerring - absolute precision - wear-resistant
 ... perfect power transmission included

That is what the new series **Power-Grip³** screwdrivers from GEDORE are
 ... the reliable all-rounders for all work in wood, plastic and metal

Seized screws are loosened by gently knocking on the striking cap. Full-length blade transfers the full 100 % impact force onto the blade tip.

- Soft fast turning zone with hard power point - gets the power there quickly
- Power point also ensures that the forefinger reliably guides the blade

 **The torque required by the German Standards Institute (DIN/ISO) is exceeded considerably**
The ideal all-rounder for screws in wood, plastic and metal

 **GEDORE has two different blade types for slotted head screws:**

Workshop tip = wedge-shaped blade in acc. with DIN ISO 2380-1 Form-A

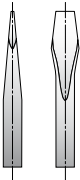

Workshop tip for all types of bolting work.
 Screwdriver tip is wedge-shaped
 Little parallel surface of nominal thickness DIN ISO 2380-1 Form-A

Electrician tip = slender, parallel blade in acc. with DIN ISO 2380-1 Form-B

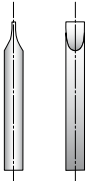

Electrician tip specially for screws deep down in the screw shaft e.g. with wire connectors and sockets.
 Extensive parallel surface of nominal thickness, no wedge-shape
 DIN ISO 2380-1 Form-B



+ Head marking for specifically and rapidly accessing the right screwdriver

+ Useful hanging hole

- + Ergonomic grip design for optimum power transfer
- Maximum force involving minimum effort
- Extensive contact surface with the hand
- Ergonomically appropriately placed hard and soft elements give the grip its GEDORE typical kind-to-hands feel
- Suitable for small hands, large hands and for both right and left-handers

+ Blade injected as a positive fit into the plastic core and matt chrome-plated

+ The hard core is inside the grip. It takes up the force from the external components and easily transfers it to the shaft. The hard core can be seen at the head marking

+ Blade fully tempered for a long service life

Blade from GEDORE molybdenum-vanadium-Plus tempered steel for hardness, elasticity and resistance to wear

+ Precision-made blade tip ensures optimum power transfer onto the screw head

www.tashev-garvin.com

POWER-GRIP³



3C-SCREWDRIVER

2150

3C-SCREWDRIVER for slotted head screws

- Acc. to DIN ISO 2380-2, blade tip acc. to DIN ISO 2380-1 Form A
- 3-component handles Power-Grip³ with hanging hole
- Ergonomic handle design enables precise and fatigue-free working
- Positive-fit joint of handle and blade for optimum transmission of force
- Type of drive marked at end of the handle
- Blade from GEDORE molybdenum-vanadium-Plus tempered steel
- * Length not standardised



mm ±	mm ±	mm ±	*	mm ±	Ø	kg	Code	No.
3.0	0.5	80	*	165	3,0	0.039	6679270	2150 3
3.5	0.6	75		160	3,5	0.055	2822644	2150 3,5
4.0	0.8	100		185	4,0	0.061	6679350	2150 4
4.5	0.8	90	*	190	4,0	0.100	2822652	2150 4,5
5.5	1.0	100		200	5,0	0.093	6679430	2150 5,5
6.5	1.2	150		260	6,0	0.128	6679510	2150 6,5
8.0	1.2	150		270	7,0	0.170	6679780	2150 8
8.0	1.6	175		295	7,0	0.222	2822660	2150 8-175
10.0	1.6	200		320	8,0	0.203	6679860	2150 10
10.0	1.6	300	*	420	8,0	0.222	2822679	2150 10-300
12.0	2.0	200		320	9,0	0.257	6679940	2150 12
12.0	2.0	250		370	9,0	0.222	2822687	2150 12-250

2150

3C-SCREWDRIVER for slotted head screws, special lengths

- Acc. to DIN ISO 2380-2, blade tip acc. to DIN ISO 2380-1 Form B
- 3-component handles Power-Grip³ with hanging hole
- Ergonomic handle design enables precise and fatigue-free working
- Positive-fit joint of handle and blade for optimum transmission of force
- Type of drive marked at end of the handle
- Blade from GEDORE molybdenum-vanadium-Plus tempered steel
- * Length not standardised



mm ±	mm ±	mm ±	*	mm ±	Ø	kg	Code	No.
2.0	0.4	60	*	145	2,0	0.055	2822695	2150 2-60
2.5	0.4	75		160	2,5	0.055	2822709	2150 2,5-75
3.0	0.5	150	*	235	3,0	0.044	6680280	2150 3-150
3.0	0.5	200	*	285	3,0	0.055	2822717	2150 3-200
3.5	0.6	100		185	3,5	0.055	2822725	2150 3,5-100
3.5	0.6	125		210	3,5	0.055	2822733	2150 3,5-125
3.5	0.6	200	*	285	3,5	0.055	2822741	2150 3,5-200
4.0	0.8	150	*	235	4,0	0.069	6680360	2150 4-150
4.0	0.8	200	*	285	4,0	0.055	2822768	2150 4-200
4.0	0.8	300	*	385	4,0	0.055	2822776	2150 4-300
5.5	1.0	125		225	5,5	0.100	2822784	2150 5,5-125
5.5	1.0	150		250	5,5	0.104	6680520	2150 5,5-150
5.5	1.0	200	*	300	5,5	0.100	2822792	2150 5,5-200
5.5	1.0	300	*	400	5,5	0.100	2822806	2150 5,5-300
6.0	1.2	100	*	210	6,0	0.140	2822814	2150 6-100
6.5	1.2	200	*	310	6,0	0.152	6680870	2150 6,5-200

2153

3C-SCREWDRIVER for slotted head screws, stubby

- Acc. to DIN ISO 2380-2A, blade tip acc. to DIN ISO 2380-1 Form B
- For confined spaces
- 3-component handles Power-Grip³ with hanging hole
- Ergonomic handle design enables precise and fatigue-free working
- Positive-fit joint of handle and blade for optimum transmission of force
- Type of drive marked at end of the handle
- Blade from GEDORE molybdenum-vanadium-Plus tempered steel



mm ±	mm ±	mm ±	mm ±	kg	Code	No.
4.0	0.8	25	81	0.031	1531174	2153 4
5.5	1.0	25	81	0.036	1482432	2153 5,5
6.5	1.2	25	81	0.039	1531182	2153 6,5
8.0	1.2	25	81	0.044	1531190	2153 8

2160 PH

3C-SCREWDRIVER for cross-head screws PH

- Acc. to DIN ISO 8764, tip acc. to DIN ISO 8764-1 PH
- 3-component handles Power-Grip³ with hanging hole
- Ergonomic handle design enables precise and fatigue-free working
- Positive-fit joint of handle and blade for optimum transmission of force
- Type of drive marked at end of the handle
- Size 3 and 4 blade with hexagon bolster
- Blade from GEDORE molybdenum-vanadium-Plus tempered steel
- * not standardised



PH	M	mm ±	*	mm ±	kg	Code	No.
0	M1,6 - M2	60		145	0.302	6683110	2160 PH 0
0	M1,6 - M2	100	*	185	0.055	2824043	2160 PH 0-100
1	M2 - M3	80		180	0.080	6683380	2160 PH 1
1	M2 - M3	100	*	200	0.100	2824051	2160 PH 1-100
1	M2 - M3	200		300	0.166	6683700	2160 PH 1-200
2	M3,5 - M5	100		210	0.119	6683460	2160 PH 2
2	M3,5 - M5	150	*	260	0.140	2824078	2160 PH 2-150
2	M3,5 - M5	200		310	0.164	6683890	2160 PH 2-200
3	M5,5 - M7	150		270	0.192	6683540	2160 PH 3
4	M8 - M10	200		320	0.274	6683620	2160 PH 4





2161 PH

3C-SCREWDRIVER for cross-head screws PH, stubby

- Acc. to DIN ISO 8764, tip acc. to DIN ISO 8764-1 PH
- For confined spaces
- 3-component handles Power-Grip³ with hanging hole
- Ergonomic handle design enables precise and fatigue-free working
- Positive-fit joint of handle and blade for optimum transmission of force
- Type of drive marked at end of the handle
- Blade from GEDORE molybdenum-vanadium-Plus tempered steel



PH	M	i-mm	i-mm	kg	Code	No.
1	M2 - M3	25	81	0.033	1482440	2161 PH 1
2	M3,5 - M5	25	81	0.036	1531204	2161 PH 2



VDE 2160 PH

539



VDE 2160 PZ

539



2161 PZ

3C-SCREWDRIVER for cross-head screws Pozi PZ, stubby

- Acc. to DIN ISO 8764, tip acc. to DIN ISO 8764-1 PZ
- For confined spaces
- 3-component handles Power-Grip³ with hanging hole
- Ergonomic handle design enables precise and fatigue-free working
- Positive-fit joint of handle and blade for optimum transmission of force
- Type of drive marked at end of the handle
- Blade from GEDORE molybdenum-vanadium-Plus tempered steel

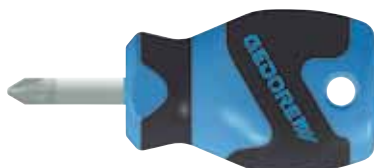

PZ	M	i-mm	i-mm	kg	Code	No.
1	M2 - M3	25	81	0.032	1550608	2161 PZ 1
2	M3,5 - M5	25	81	0.037	1550616	2161 PZ 2

2160 PZ

3C-SCREWDRIVER for cross-head screws Pozi PZ

- Acc. to DIN ISO 8764, tip acc. to DIN ISO 8764-1 PZ
- 3-component handles Power-Grip³ with hanging hole
- Ergonomic handle design enables precise and fatigue-free working
- Positive-fit joint of handle and blade for optimum transmission of force
- Type of drive marked at end of the handle
- Size 3 and 4 blade with hexagon bolster
- Blade from GEDORE molybdenum-vanadium-Plus tempered steel
- * not standardised



PZ	M	i-mm	*	i-mm	kg	Code	No.
0	M1,6 - M2	60		145	0.038	6683970	2160 PZ 0
1	M2 - M3	80		180	0.079	6684000	2160 PZ 1
1	M2 - M3	300	*	400	0.100	2824086	2160 PZ 1-300
2	M3,5 - M5	100		210	0.119	6684190	2160 PZ 2
2	M3,5 - M5	300	*	410	0.140	2824094	2160 PZ 2-300
3	M5,5 - M7	150		270	0.189	6684270	2160 PZ 3
4	M8 - M10	200		320	0.273	6684350	2160 PZ 4

2163 K

3C-SCREWDRIVER for in-hex screws, with ball end

- 3-component handles Power-Grip³ with hanging hole
- Ergonomic handle design enables precise and fatigue-free working
- Positive-fit joint of handle and blade for optimum transmission of force
- Type of drive marked at end of the handle
- Working angle approx. 25° in each direction
- Blade from GEDORE molybdenum-vanadium-Plus tempered steel



mm	i-mm	i-mm	kg	Code	No.
2	100	185	0.040	1828746	2163 K 2
3	100	185	0.045	6684430	2163 K 3
4	100	185	0.068	6684510	2163 K 4
5	100	200	0.100	6684780	2163 K 5
6	125	235	0.139	6684860	2163 K 6
8	150	270	0.230	6684940	2163 K 8
10	150	270	0.285	6685080	2163 K 10
12	150	270	0.369	6685160	2163 K 12



2163 TX

3C-SCREWDRIVER for recessed TORX® head screws

- ▶ 3-component handles Power-Grip³ with hanging hole
- ▶ Ergonomic handle design enables precise and fatigue-free working
- ▶ Positive-fit joint of handle and blade for optimum transmission of force
- ▶ Type of drive marked at end of the handle
- ▶ Blade from GEDORE molybdenum-vanadium-Plus tempered steel
- ▶ TORX® = reg. trademark of Acument Intellectual Properties, LLC. USA

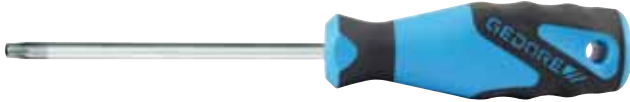

⊕	M	mm	mm	mm	kg	Code	No.
T5	M1,8	1,42	60	145	0.037	1616471	2163 TX T5
T6	M2	1,69	60	145	0.029	6685400	2163 TX T6
T7	M2,5	1,99	60	145	0.038	6685590	2163 TX T7
T8	M2,5	2,31	60	145	0.038	6685670	2163 TX T8
T9	M3	2,50	60	145	0.038	6685750	2163 TX T9
T10	M3 - M3,5	2,74	80	165	0.039	6685830	2163 TX T10
T15	M3,5 - M4	3,27	80	165	0.054	6685910	2163 TX T15
T20	M4 - M5	3,86	100	185	0.060	6686050	2163 TX T20
T25	M4,5 - M5	4,43	100	200	0.082	6686130	2163 TX T25
T27	M4,5 - M6	4,99	115	215	0.098	6686210	2163 TX T27
T30	M6 - M7	5,52	115	225	0.123	6686480	2163 TX T30
T40	M7 - M8	6,65	130	240	0.144	6686560	2163 TX T40
T45	M8 - M10	7,82	130	250	0.176	6686640	2163 TX T45

2163 TXB

3C-SCREWDRIVER for recessed TORX® head screws with pilot

- ▶ 3-component handles Power-Grip³ with hanging hole
- ▶ Ergonomic handle design enables precise and fatigue-free working
- ▶ Positive-fit joint of handle and blade for optimum transmission of force
- ▶ Type of drive marked at end of the handle
- ▶ Blade from GEDORE molybdenum-vanadium-Plus tempered steel
- ▶ TORX® = reg. trademark of Acument Intellectual Properties, LLC. USA



⊕	M	mm	mm	mm	kg	Code	No.
T7	M2,5	1,99	60	145	0.034	6677570	2163 TXB T7
T8	M2,5	2,31	60	145	0.038	6677650	2163 TXB T8
T9	M3	2,50	60	145	0.038	6677730	2163 TXB T9
T10	M3 - M3,5	2,74	80	165	0.039	6677810	2163 TXB T10
T10	M3 - M3,5	2,74	300	385	0.055	2824159	2163 TXB T10-300
T15	M3,5 - M4	3,27	80	165	0.054	6678030	2163 TXB T15
T15	M3,5 - M4	3,27	300	385	0.055	2824167	2163 TXB T15-300
T20	M4 - M5	3,86	100	185	0.060	6678110	2163 TXB T20
T20	M4 - M5	3,86	300	385	0.055	2824175	2163 TXB T20-300
T25	M4,5 - M5	4,43	100	200	0.082	6678380	2163 TXB T25
T27	M4,5 - M6	4,99	115	215	0.098	6678460	2163 TXB T27
T30	M6 - M7	5,52	115	225	0.123	6678540	2163 TXB T30
T40	M7 - M8	6,65	130	240	0.143	6678620	2163 TXB T40



2163 TXIP

3C-SCREWDRIVER for recessed TORX PLUS® head screws

- ▶ 3-component handles Power-Grip³ with hanging hole
- ▶ Ergonomic handle design enables precise and fatigue-free working
- ▶ Positive-fit joint of handle and blade for optimum transmission of force
- ▶ Type of drive marked at end of the handle
- ▶ Blade from GEDORE molybdenum-vanadium-Plus tempered steel
- ▶ TORX PLUS® = reg. trademark of Acument Intellectual Properties, LLC. USA

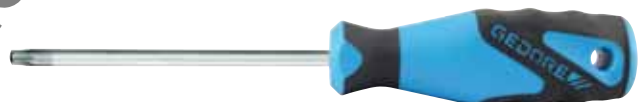

⊕	M	mm	mm	mm	kg	Code	No.
6IP	M2	2,31	60	145	0.055	2824299	2163 TX 6IP
7IP	-	-	60	145	0.055	2824302	2163 TX 7IP
8IP	M2,5 - M3	2,50	60	145	0.055	2824310	2163 TX 8IP
9IP	-	-	60	145	0.055	2824329	2163 TX 9IP
10IP	M3 - M3,5	2,74	80	165	0.055	2824337	2163 TX 10IP
15IP	M3,5 - M4	3,27	80	165	0.055	2824345	2163 TX 15IP
20IP	M4 - M5	3,86	100	185	0.055	2824353	2163 TX 20IP
25IP	M4,5 - M5	4,43	100	200	0.100	2824361	2163 TX 25IP
27IP	M5 - M6	4,99	115	215	0.100	2824388	2163 TX 27IP
30IP	M6	5,52	115	225	0.140	2824396	2163 TX 30IP
40IP	M7 - M8	6,65	130	240	0.140	2824418	2163 TX 40IP

2163 KTX

3C-SCREWDRIVER for recessed TORX® screws with ball end

- ▶ 3-component handles Power-Grip³ with hanging hole
- ▶ Ergonomic handle design enables precise and fatigue-free working
- ▶ Positive-fit joint of handle and blade for optimum transmission of force
- ▶ Type of drive marked at end of the handle
- ▶ Working angle approx. 25° in each direction
- ▶ Blade from GEDORE molybdenum-vanadium-Plus tempered steel
- ▶ TORX® = reg. trademark of Acument Intellectual Properties, LLC. USA



⊕	M	mm	mm	mm	kg	Code	No.
T10	M3 - M3,5	2,74	80	165	0.055	2824213	2163 KTX T10
T15	M3,5 - M4	3,27	80	165	0.055	2824221	2163 KTX T15
T20	M4 - M5	3,86	100	185	0.055	2824248	2163 KTX T20
T25	M4,5 - M5	4,43	100	200	0.100	2824256	2163 KTX T25
T27	M4,5 - M6	4,99	115	215	0.100	2824264	2163 KTX T27
T30	M6 - M7	5,52	115	225	0.140	2824272	2163 KTX T30
T40	M7 - M8	6,65	130	240	0.140	2824280	2163 KTX T40

VDE 2170

538





3C-SCREWDRIVER SETS

2150-2160 PH

3C-SCREWDRIVER SET 6 pieces / 10 pieces

- Practical set composition in environmentally-friendly cardboard box
- 3-component handles Power-Grip³ with hanging hole
- Ergonomic handle design enables precise and fatigue-free working
- Positive-fit joint of handle and blade for optimum transmission of force
- Type of drive marked at end of the handle
- Blade from GEDORE molybdenum-vanadium-Plus tempered steel



Contents	kg	Code	No.
2150 4 5,5 6,5 8	0.660	1482319	2150-2160 PH-06
2160 PH 1 2			
2150 3 4 5,5 6,5 8	0.825	1482343	2150-2160 PH-010
2153 5,5			
2160 PH 1 2			
2161 PH 1			
4615 3,5			

2150-2160 PZ-06

3C-SCREWDRIVER SET 6 pieces

- Practical set composition in environmentally-friendly cardboard box
- For slotted and cross-slotted head screws PZ
- 3-component handles Power-Grip³ with hanging hole
- Ergonomic handle design enables precise and fatigue-free working
- Positive-fit joint of handle and blade for optimum transmission of force
- Type of drive marked at end of the handle
- Blade from GEDORE molybdenum-vanadium-Plus tempered steel

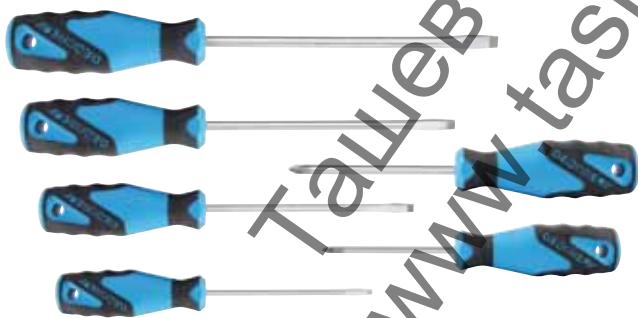

Contents	kg	Code	No.
2150 4 5,5 6,5 8	0.670	1482300	2150-2160 PZ-06
2160 PZ 1 2			

VDE 2170-2160 PH-077

539

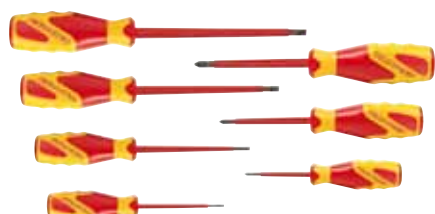

2160 PHZ-06

3C-SCREWDRIVER SET 6 pieces

- Practical set composition in environmentally-friendly cardboard box
- For cross-slotted head screws PH and PZ
- 3-component handles Power-Grip³ with hanging hole
- Ergonomic handle design enables precise and fatigue-free working
- Positive-fit joint of handle and blade for optimum transmission of force
- Type of drive marked at end of the handle
- Blade from GEDORE molybdenum-vanadium-Plus tempered steel

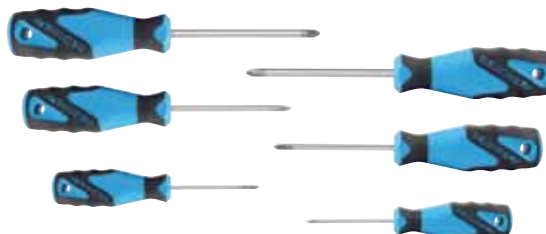

Contents	kg	Code	No.
2160 PH 0 1 2	0.344	2003589	2160 PHZ-06
2160 PZ 0 1 2			

2163 TX

3C-SCREWDRIVER SET 5 pieces / 10 pieces

- Practical set composition in environmentally-friendly cardboard box
- For recessed TORX[®] head screws
- 3-component handles Power-Grip³ with hanging hole
- Ergonomic handle design enables precise and fatigue-free working
- Positive-fit joint of handle and blade for optimum transmission of force
- Type of drive marked at end of the handle
- Blade from GEDORE molybdenum-vanadium-Plus tempered steel
- TORX[®] = reg. trademark of Acument Intellectual Properties, LLC. USA

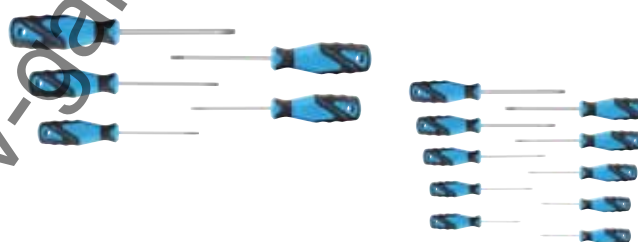

Contents	kg	Code	No.
2163 TX T10 T15 T20 T25 T30	0.435	1482327	2163 TX-05
2163 TX T7 T8 T9 T10 T15 T20 T25 T27 T30 T40	0.740	1482335	2163 TX-010

2163 TXB-05

3C-SCREWDRIVER SET 5 pieces

- Practical set composition in environmentally-friendly cardboard box
- For recessed TORX[®] head screws with pilot
- 3-component handles Power-Grip³ with hanging hole
- Ergonomic handle design enables precise and fatigue-free working
- Positive-fit joint of handle and blade for optimum transmission of force
- Type of drive marked at end of the handle
- Blade from GEDORE molybdenum-vanadium-Plus tempered steel
- TORX[®] = reg. trademark of Acument Intellectual Properties, LLC. USA



Contents	kg	Code	No.
2163 TXB T10 T15 T20 T25 T30	0.440	1616617	2163 TXB-05



3C-SCREWDRIVER WITH STRIKING CAP

2154SK

3C-SCREWDRIVER WITH STRIKING CAP for slotted head screws

- Acc. to DIN ISO 2380-2, blade tip acc. to DIN ISO 2380-1 Form A
- 3-component handles Power-Grip³ with striking cap
- Ergonomic handle design enables precise and fatigue-free working
- Positive-fit joint of handle and blade for optimum transmission of force
- Hexagon blade with additional hexagon bolster
- Blade from GEDORE molybdenum-vanadium-Plus tempered steel



mm	mm	mm	mm	mm	kg	Code	No.
3.5	0.6	75	180	8	0.086	1845209	2154SK 3,5
4.5	0.8	75	180	8	0.090	1845217	2154SK 4,5
5.5	1.0	100	205	8	0.092	1845225	2154SK 5,5
6.5	1.2	125	230	10	0.154	1845233	2154SK 6,5
6.5	1.2	150	255	10	0.229	2824108	2154SK 6,5-150
7.0	1.2	125	230	10	0.229	2824116	2154SK 7
8.0	1.2	150	270	13	0.178	1845241	2154SK 8
8.0	1.6	175	295	13	0.229	2824124	2154SK 8-175
10.0	1.6	200	320	13	0.214	1845268	2154SK 10
10.0	1.6	300	420	13	0.229	2824132	2154SK 10-300
12.0	2.0	200	320	16	0.260	1845276	2154SK 12
12.0	2.0	250	370	16	0.229	2824140	2154SK 12-250
14.0	2.5	250	370	16	0.324	1845284	2154SK 14

2160SK PZ

3C-SCREWDRIVER WITH STRIKING CAP for cross-head screws Pozi PZ

- Acc. to DIN ISO 8764, tip acc. to DIN ISO 8764-1 PZ
- 3-component handles Power-Grip³ with striking cap
- Ergonomic handle design enables precise and fatigue-free working
- Positive-fit joint of handle and blade for optimum transmission of force
- Hexagon blade with additional hexagon bolster
- Blade from GEDORE molybdenum-vanadium-Plus tempered steel



PZ	M	mm	mm	mm	kg	Code	No.
1	M2 - M3	80	185	8	0.086	1845330	2160SK PZ 1
2	M3,5 - M5	100	205	10	0.148	1845349	2160SK PZ 2
3	M5,5 - M7	150	270	13	0.206	1845357	2160SK PZ 3

SK 2154 PH-06

3C-SCREWDRIVER SET WITH STRIKING CAP 6 pieces

- Practical set composition in environmentally-friendly cardboard box
- For firmly seated slotted and cross-head screws PH
- Hexagon blade with additional hexagon bolster
- 3-component handles Power-Grip³ with striking cap
- Ergonomic handle design enables precise and fatigue-free working
- Positive-fit joint of handle and blade for optimum transmission of force
- Blade from GEDORE molybdenum-vanadium-Plus tempered steel

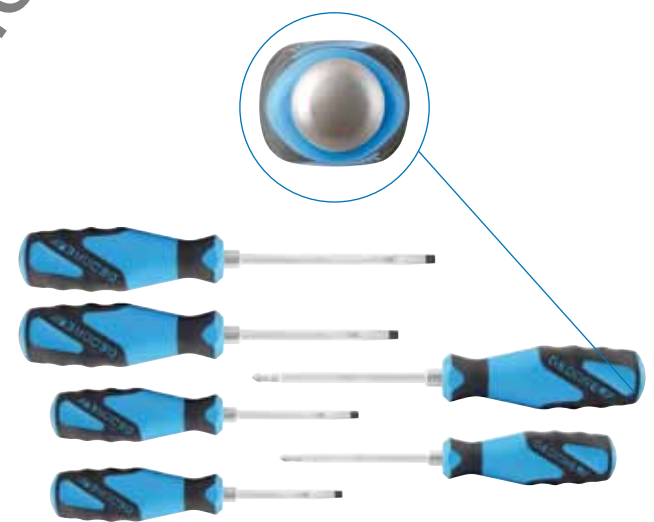
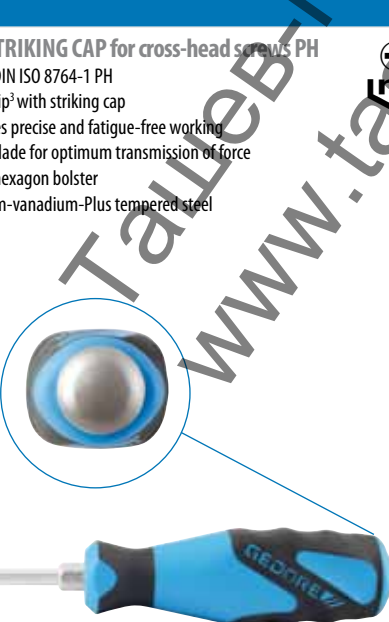

Contents	kg	Code	No.
2154SK 4,5 5,5 6,5 8	0.880	1878743	SK 2154 PH-06
2160SK PH 1 2			

PH	M	mm	mm	mm	kg	Code	No.
1	M2 - M3	80	185	8	0.086	1845292	2160SK PH 1
2	M3,5 - M5	100	205	10	0.148	1845306	2160SK PH 2
3	M5,5 - M7	150	270	13	0.204	1845314	2160SK PH 3
4	M8 - M10	200	320	16	0.292	1845322	2160SK PH 4



SCREWDRIVER WITH WOODEN HANDLE

147

SCREWDRIVER for slotted head screws

- Similar to DIN ISO 2380-2 Row B+C, blade tip acc. to DIN ISO 2380-1 Form A
- Blade tanged right through the handle, chrome-plated
- GEDORE vanadium steel 50CrV4
- Hardwood handle, clear varnished with leather cap
- Hexagon bolster for higher transmission of force

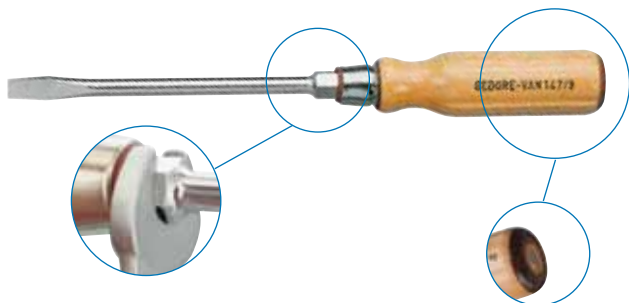

mm	mm	mm	mm	mm	kg	Code	No.
3.5	0.6	75	170	6	0.055	6413830	147 3,5
4.5	0.8	90	185	6	0.059	6413910	147 4,5
5.5	1.0	100	200	8	0.073	6414050	147 5,5
7.0	1.2	125	235	10	0.112	6414130	147 7
9.0	1.4	150	270	12	0.166	6414210	147 9
10.0	1.6	175	300	12	0.192	6414480	147 10
12.0	2.0	200	330	13	0.250	6414560	147 12

148

SCREWDRIVER for slotted head screws

- Similar to DIN ISO 2380-2 Row B+C, blade tip acc. to DIN ISO 2380-1 Form A
- Hexagon blade with forged bolster for higher transmission of force
- Blade tanged right through the handle, chrome-plated
- GEDORE vanadium steel 50CrV4
- Hardwood handle, clear varnished with leather cap

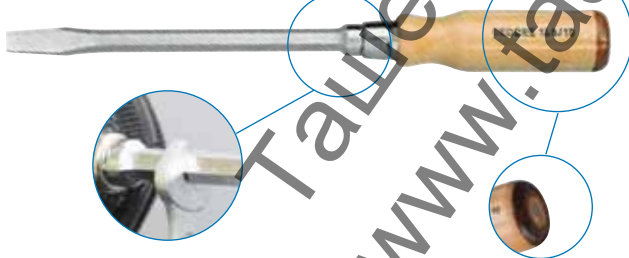

mm	mm	mm	mm	mm	kg	Code	No.
5.5	0.8	100	200	6	0.083	6415020	148 5,5
7.0	1.0	125	230	7	0.123	6415100	148 7
8.0	1.2	150	270	8	0.174	6415290	148 8
10.0	1.6	175	300	8	0.233	6415370	148 10
12.0	2.0	200	330	12	0.381	6415450	148 12
14.0	2.5	250	390	12	0.478	6415530	148 14

www.gedore.com

162

SCREWDRIVER for cross-head screws PH

- Similar to DIN ISO 8764-2, tip acc. to DIN ISO 8764-1 PH
- Blade tanged right through the handle, chrome-plated
- GEDORE vanadium steel 50CrV4
- Hardwood handle, clear varnished with leather cap
- Hexagon bolster for higher transmission of force

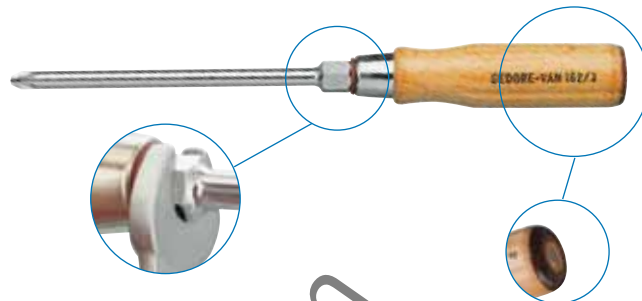

PH						Code	No.
1	M 2 - M 3	80	180	6	0.058	6429400	162 1
2	M 3,5 - M 5	100	210	10	0.096	6429590	162 2
3	M 6	150	275	12	0.172	6429670	162 3
4	M 8 - M 10	200	340	17	0.325	6429750	162 4

147-04

SCREWDRIVER SET 4 pieces

- Work-orientated assortment packed in environmentally-friendly cardboard box
- Blade tanged right through the handle, chrome-plated
- GEDORE vanadium steel 50CrV4
- Hardwood handle, clear varnished with leather cap
- Hexagon bolster for higher transmission of force

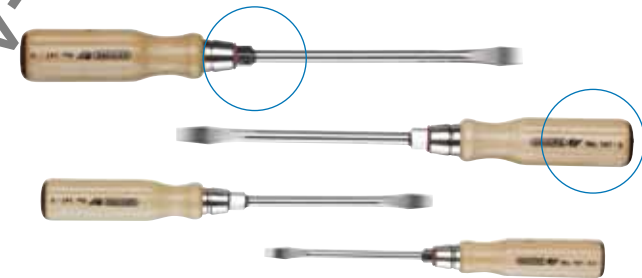

Contents	kg	Code	No.
147 5,5 7 9 10	0.585	6422820	147-04

147-162-05

SCREWDRIVER SET 5 pieces

- Work-orientated assortment packed in environmentally-friendly cardboard box
- Blade tanged right through the handle, chrome-plated
- GEDORE vanadium steel 50CrV4
- Hardwood handle, clear varnished with leather cap
- Hexagon bolster for higher transmission of force

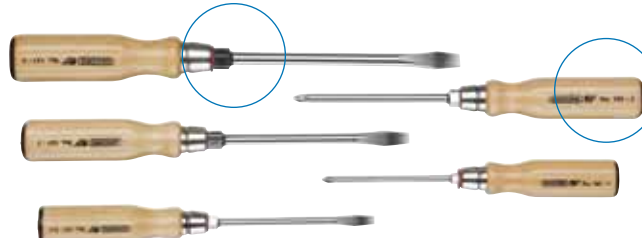

Contents	kg	Code	No.
147 5,5 7 9 162 1 2	0.535	6423120	147-162-05



ELECTRONIC SCREWDRIVER

171 IS

ELECTRONIC SCREWDRIVER for slotted head screws

- Blade in high-alloy chrome-vanadium-molybdenum steel, chrome-plated
- Tip additionally coated for highest precision and corrosion protection
- 2-component-handle in ergonomic design
- Pivoting end cap with micro anti-slip surface
- Colour coding of the drive type



mm	mm	mm	Ø	kg	Code	No.
1.2	155	60	2,5	0.017	1845004	171 IS 1,2
1.5	155	60	2,5	0.014	6436450	171 IS 1,5
1.8	155	60	2,5	0.017	1845012	171 IS 1,8
2.0	155	60	2,5	0.017	6438660	171 IS 2
2.5	170	75	2,5	0.020	1845020	171 IS 2,5
3.0	195	100	3,0	0.023	1845039	171 IS 3

165 PH

ELECTRONIC SCREWDRIVER for cross-head screws PH

- Blade in high-alloy chrome-vanadium-molybdenum steel, chrome-plated
- Tip additionally coated for highest precision and corrosion protection
- 2-component-handle in ergonomic design
- Pivoting end cap with micro anti-slip surface
- Colour coding of the drive type



PH	M	mm	mm	Ø	kg	Code	No.
000		60	155	2,5	0.018	1845047	165 PH 000
00		60	155	2,5	0.016	6442770	165 PH 00
0	M1,6 - M2	60	155	3,0	0.018	6442930	165 PH 0
1	M2-M3	80	175	4,5	0.031	1845055	165 PH 1

164 IN

ELECTRONIC SCREWDRIVER for in-hex screws

- Blade in high-alloy chrome-vanadium-molybdenum steel, chrome-plated
- Tip additionally coated for highest precision and corrosion protection
- 2-component-handle in ergonomic design
- Pivoting end cap with micro anti-slip surface
- Colour coding of the drive type



mm	mm	mm	Ø	kg	Code	No.
0,7	60	155	2,5	0.018	1845063	164 IN 0,7
0,9	60	155	2,5	0.018	1845071	164 IN 0,9
1,3	60	155	2,5	0.017	6443150	164 IN 1,3
1,5	60	155	2,5	0.017	6443230	164 IN 1,5
2	60	155	2,5	0.019	6443310	164 IN 2
2,5	60	155	3,0	0.016	6443580	164 IN 2,5
3	60	155	3,5	0.022	6443740	164 IN 3

165 TX

ELECTRONIC SCREWDRIVER for recessed TORX® head screws

- Blade in high-alloy chrome-vanadium-molybdenum steel, chrome-plated
- Tip additionally coated for highest precision and corrosion protection
- 2-component-handle in ergonomic design
- Pivoting end cap with micro anti-slip surface
- Colour coding of the drive type
- TORX® = reg. trademark of Acument Intellectual Properties, LLC. USA



T	M	mm	mm	mm	Ø	kg	Code	No.
T3	M1,2 - M1,4	1,13	60	155	2,5	0.016	1845098	165 TX T3
T4	M1,4	1,29	60	155	2,5	0.016	1845101	165 TX T4
T5	M1,8	1,42	60	155	2,5	0.017	1845128	165 TX T5
T6	M2	1,69	60	155	3,0	0.019	1845136	165 TX T6
T7	M2,5	1,99	60	155	3,0	0.019	1845144	165 TX T7
T8	M2,5	2,31	60	155	3,0	0.019	1845152	165 TX T8
T9	M3	2,50	60	155	3,0	0.019	1845160	165 TX T9
T10	M3 - M3,5	2,74	60	155	3,0	0.020	1845179	165 TX T10
T15	M3,5 - M4	3,27	60	155	3,5	0.023	1845187	165 TX T15
T20	M4 - M5	3,86	80	175	4,0	0.029	1845195	165 TX T20

165-171-06

ELECTRONIC SCREWDRIVER SET 6 pieces

- For slotted head and cruciform head screws PH
- Blade in high-alloy chrome-vanadium-molybdenum steel, chrome-plated
- Tip additionally coated for highest precision and corrosion protection
- 2-component-handle in ergonomic design
- Pivoting end cap with micro anti-slip surface
- Colour coding of the drive type
- In plastic case
- With "Check-Tool-System": 2-colour foam insert to check that the set is complete



Contents	kg	Code	No.
165 PH 000 00 0	0.385	1902849	165-171-06
171 IS 1,2 1,8 2,5			



165 TX-06

ELECTRONIC SCREWDRIVER SET 6 pieces

- For recessed TORX® head screws
- Blade in high-alloy chrome-vanadium-molybdenum steel, chrome-plated
- Tip additionally coated for highest precision and corrosion protection
- 2-component-handle in ergonomic design
- Pivoting end cap with micro anti-slip surface
- Colour coding of the drive type
- In plastic case
- With "Check-Tool-System": 2-colour foam insert to check that the set is complete
- TORX® = reg. trademark of Acument Intellectual Properties, LLC. USA



Contents	Weight	Code	No.
165 TX T5 T6 T7 T8 T9 T10	0.415	1902857	165 TX-06

1021

ELECTRONIC SCREWDRIVER SET 7 pieces

- In plastic case
- Dimensions: 275 x 150 x 42 mm



Contents	Weight	Code	No.
171 IS 1, 2, 1,5, 2 165 PH 00 0 8305-2 8306-5	0.624	6601830	1021

ELECTRONIC SCREWDRIVER

i 2C-T-Handle

Asymmetrical 2-component wing handle for high torque level when loosening or tightening. The lengthened wing provides an optimum contact surface for the palm of one's hand. It thus easily transfers considerable forces in a relaxed hand's position.

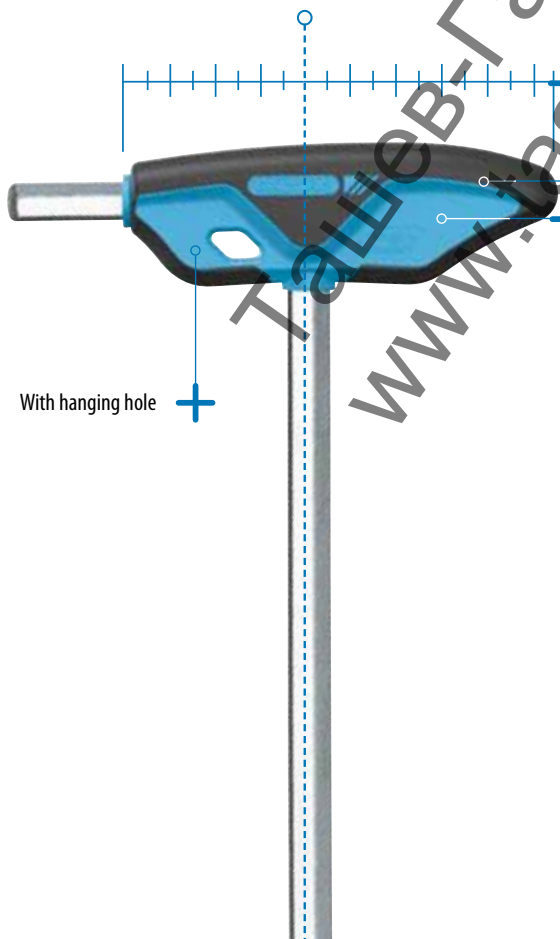

Soft component made of thermoplastic elastomer

Hard component made of fibre-glass reinforced plastic with special-purpose glass fibres. The benefits of short glass fibres (rigidity and firmness) are combined with that of long glass fibres (impact strength).

With hanging hole

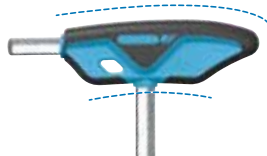

The concave form ensures exact hand centering and stops any blade tilting.

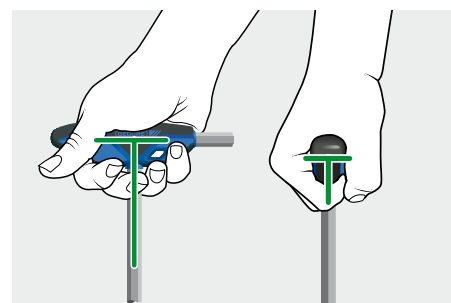

With T-shaped cross-section: broad at the top and slender below. In this way one's hand takes on a firm grip leading to vigorous working over an extended period without any fatigue.

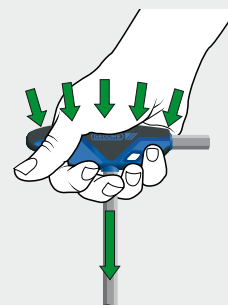

Soft zones where sensitive hand zones grip e.g. finger tips. Hard zones where robust hand zones grip.

**2142 T (MM)****HEXAGON ALLEN KEY WITH 2C-T-HANDLE**

for in-hex screws

- With hanging hole
- GEDORE vanadium steel 61CrSiV5, chromated

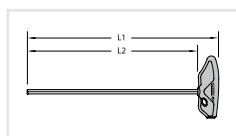

mm	L ₁	L ₂	kg	Code	No.
2	157	130	0.061	2647257	2142 T 2
2,5	187	160	0.091	2647265	2142 T 2,5
3	217	190	0.071	2647273	2142 T 3
4	248	210	0.080	2647281	2142 T 4
5	278	240	0.100	2647303	2142 T 5
6	308	270	0.140	2647311	2142 T 6
7	328	290	0.160	2681439	2142 T 7
8	348	310	0.221	2647338	2142 T 8
10	368	330	0.201	2647346	2142 T 10

DT 2142**HEXAGON ALLEN KEY WITH 2C-T-HANDLE**

for in-hex screws

- With hanging hole
- With 2 hexagons, same size each end

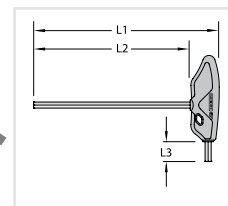
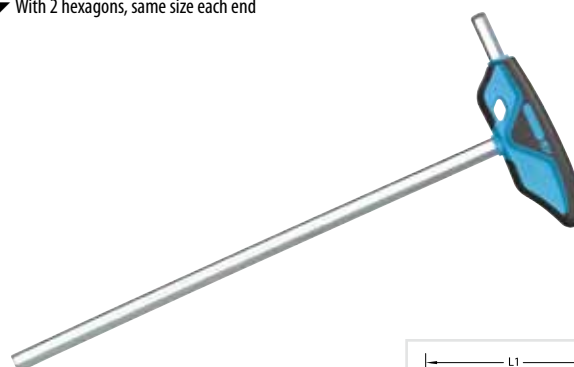

mm	L ₁	L ₂	L ₃	kg	Code	No.
2	112	85	12	0.091	2488914	DT 2142 2
2,5	132	105	12	0.071	2498596	DT 2142 2,5
3	152	125	12	0.040	2498618	DT 2142 3
4	178	140	16	0.080	2498626	DT 2142 4
5	198	160	18	0.100	2502631	DT 2142 5
6	218	180	21	0.120	2502658	DT 2142 6
7	228	190	24	0.251	2505487	DT 2142 7
8	243	205	26	0.180	2507447	DT 2142 8
10	258	220	28	0.280	2507471	DT 2142 10

2142 T (AF)**HEXAGON ALLEN KEY WITH 2C-T-HANDLE**

for in-hex screws

- With hanging hole
- GEDORE vanadium steel 61CrSiV5, chromated

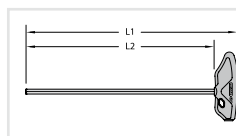

AF	L ₁	L ₂	kg	Code	No.
1/8	217	190	0.101	2647354	2142 T 1/8AF
5/32	248	210	0.121	2647362	2142 T 5/32AF
3/16	278	240	0.100	2647370	2142 T 3/16AF
1/4	308	270	0.140	2647389	2142 T 1/4AF
5/16	348	310	0.221	2647397	2142 T 5/16AF
3/8	368	330	0.201	2647400	2142 T 3/8AF

2142 TX**WRENCH KEY WITH 2C-T-HANDLE for recessed TORX® screws**

for in-hex screws

- With hanging hole
- Chrome-vanadium steel, blade chrome-plated, tip gun-metal finish
- TORX® = reg. trademark of Acument Intellectual Properties, LLC. USA

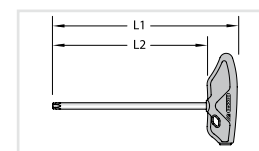
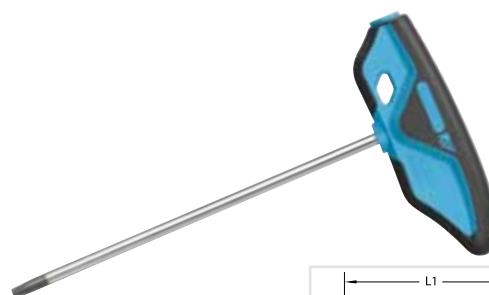

T	M	mm	L ₁	L ₂	kg	Code	No.
T5	M1,8	1,42	112	85	0.081	2509393	2142 TX T5
T6	M2	1,70	112	85	0.081	2511622	2142 TX T6
T7	M2,5	1,99	112	85	0.081	2511657	2142 TX T7
T8	M2,5	2,31	112	85	0.051	2513072	2142 TX T8
T9	M3	2,50	132	105	0.071	2513102	2142 TX T9
T10	M3 - M3,5	2,74	132	105	0.061	2513749	2142 TX T10
T15	M3,5 - M4	3,27	152	125	0.091	2516934	2142 TX T15
T20	M4 - M5	3,86	167	140	0.081	2519062	2142 TX T20
T25	M4,5 - M5	4,43	178	140	0.091	2519186	2142 TX T25
T27	M4,5 - M6	4,99	198	160	0.100	2521571	2142 TX T27
T30	M6 - M7	5,52	198	160	0.100	2521598	2142 TX T30
T40	M7 - M8	6,65	218	180	0.140	2521601	2142 TX T40
T45	M8 - M10	7,82	228	190	0.160	2521636	2142 TX T45
T50	M10	8,83	243	205	0.180	2521644	2142 TX T50

Ташев-Голвинг ООД
www.tashev-golvinng.com



DT 2143 KTX

CRANKED SOCKET KEY WITH 2C-T-HANDLE for recessed TORX® screws

- ▶ Working angle approx. 25°
- ▶ With hanging hole
- ▶ Chrome-vanadium steel, blades chrome-plated, tip phosphated
- ▶ TORX® = reg. trademark of Acument Intellectual Properties, LLC. USA

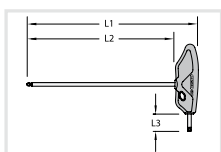

●	M	mm	L ₁	L ₂	L ₃	kg	Code	No.
T10	M3 - M3,5	2,74	157	130	12	0.091	2647486	DT 2143 KTX T10
T15	M3,5 - M4	3,27	177	150	14	0.081	2647494	DT 2143 KTX T15
T20	M4 - M5	3,86	197	170	16	0.071	2647508	DT 2143 KTX T20
T25	M4,5 - M5	4,43	228	190	19	0.121	2647516	DT 2143 KTX T25
T27	M4,5 - M6	4,99	248	210	22	0.120	2647524	DT 2143 KTX T27
T30	M6 - M7	5,52	303	265	25	0.140	2647532	DT 2143 KTX T30
T40	M7 - M8	6,65	333	295	28	0.180	2647540	DT 2143 KTX T40

42 T (AF)

HEXAGON ALLEN KEY WITH T-HANDLE for in-hex screws

- ▶ Blue handle with hanging hole
- ▶ GEDORE vanadium steel 61CrSiV5, chromated

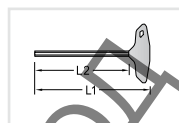

●	"AF"	L ₁	L ₂	kg	Code	No.
1/8		229	190	0.040	1996010	42 T 1/8AF
5/32		249	210	0.068	1996029	42 T 5/32AF
3/16		279	240	0.088	1996037	42 T 3/16AF
1/4		309	270	0.120	1996045	42 T 1/4AF
5/16		349	310	0.190	1996053	42 T 5/16AF
3/8		369	330	0.230	1996061	42 T 3/8AF

42 T (MM)

HEXAGON ALLEN KEY WITH T-HANDLE for in-hex screws

- ▶ Blue handle with hanging hole
- ▶ GEDORE vanadium steel 61CrSiV5, chromated

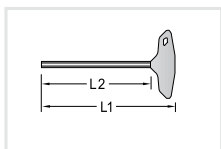

●	mm	L ₁	L ₂	kg	Code	No.
2		162.5	130	0.029	1531360	42 T 2
2,5		192.5	160	0.036	6354130	42 T 2,5
3		222.5	190	0.040	6353670	42 T 3
4		249.0	210	0.073	6353750	42 T 4
5		279.0	240	0.093	6353830	42 T 5
6		309.0	270	0.124	6353910	42 T 6
7		329.0	290	0.157	6366730	42 T 7
8		349.0	310	0.198	6354050	42 T 8
10		369.0	330	0.295	6354210	42 T 10

DT 42

HEXAGON ALLEN KEY WITH T-HANDLE for in-hex screws

- ▶ Blue handle with hanging hole
- ▶ With 2 hexagons, same size each end

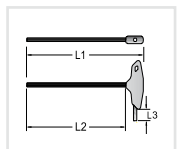
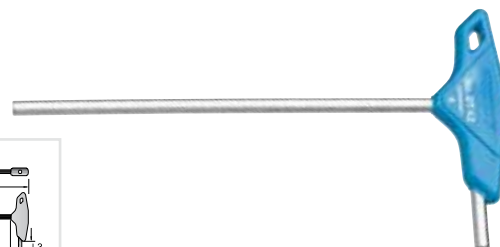

●	mm	L ₁	L ₂	L ₃	kg	Code	No.
2		107.0	87	12.0	0.012	1476408	DT 42 2
2,5		127.0	107	12.0	0.015	1476424	DT 42 2,5
3		147.0	127	12.0	0.019	1476432	DT 42 3
4		173.5	141	15.5	0.049	1476440	DT 42 4
5		193.5	161	17.5	0.068	1476459	DT 42 5
6		213.5	181	20.5	0.091	1476467	DT 42 6
7		231.0	192	28.0	0.142	1476475	DT 42 7
8		246.0	207	28.0	0.175	1476483	DT 42 8
10		261.0	222	28.0	0.257	1476491	DT 42 10

V 42 T

538



1500 CT2-DT 42

109





42 TX

WRENCH KEY WITH T-HANDLE for recessed TORX® screws

- ▶ Blue handle with hanging hole
- ▶ Chrome-vanadium steel, blade chrome-plated, tip gun-metal finish
- ▶ TORX® = reg. trademark of Acument Intellectual Properties, LLC. USA

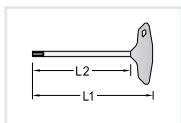
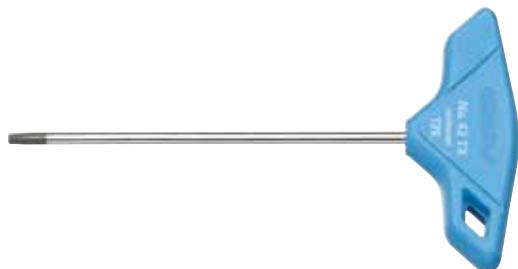

Code	M	mm	L ₁	L ₂	kg	No.
T5	M1,8	1,42	107,0	87	0.018	42 TX T5
T6	M2	1,70	107,0	87	0.018	42 TX T6
T7	M2,5	1,99	107,0	87	0.018	42 TX T7
T8	M2,5	2,31	119,5	87	0.033	42 TX T8
T9	M3	2,50	139,5	107	0.038	42 TX T9
T10	M3 - M3,5	2,74	139,5	107	0.041	42 TX T10
T15	M3,5 - M4	3,27	159,5	127	0.042	42 TX T15
T20	M4 - M5	3,86	173,5	141	0.043	42 TX T20
T25	M4,5 - M5	4,43	180,0	141	0.064	42 TX T25
T27	M4,5 - M6	4,99	200,0	161	0.084	42 TX T27
T30	M6 - M7	5,52	200,0	161	0.090	42 TX T30
T40	M7 - M8	6,65	220,0	181	0.115	42 TX T40
T45	M8 - M10	7,82	231,0	192	0.139	42 TX T45
T50	M10	8,83	246,0	207	0.181	42 TX T50

V 42 538



DTT 42

HEXAGON ALLEN KEY for in-hex screws

- ▶ With 3 hexagons, same size each end
- ▶ T-handle fixed



mm	L ₁	L ₂	L ₃	Ø	kg	Code	No.
3	150	75	30	5.0	0.042	1669540	DTT 42 3
4	180	90	35	6.0	0.064	1669559	DTT 42 4
5	180	90	35	7.0	0.092	1669567	DTT 42 5
6	210	105	40	8.0	0.134	1669575	DTT 42 6
8	250	125	50	9.5	0.224	1669583	DTT 42 8
10	300	150	60	12.0	0.418	1669591	DTT 42 10

DT 43 KTX

CRANKED SOCKET KEY WITH T-HANDLE for recessed TORX® screws

- ▶ Working angle approx. 25°
- ▶ Blue handle with hanging hole
- ▶ Chrome-vanadium steel, blades chrome-plated, tip phosphated
- ▶ TORX® = reg. trademark of Acument Intellectual Properties, LLC. USA



Code	M	mm	L ₁	L ₂	L ₃	kg	No.
T10	M3 - M3,5	2,74	150	130	12	0.024	DT 43 KTX T10
T15	M3,5 - M4	3,27	170	150	12	0.027	DT 43 KTX T15
T20	M4 - M5	3,86	202	170	16	0.058	DT 43 KTX T20
T25	M4,5 - M5	4,43	222	190	18	0.067	DT 43 KTX T25
T27	M4,5 - M6	4,99	242	210	20	0.094	DT 43 KTX T27
T30	M6 - M7	5,52	279	240	28	0.126	DT 43 KTX T30
T40	M7 - M8	6,65	309	270	28	0.171	DT 43 KTX T40

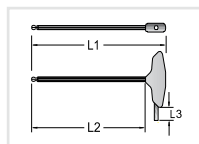



i 42 DKEL - The first with two ball ends

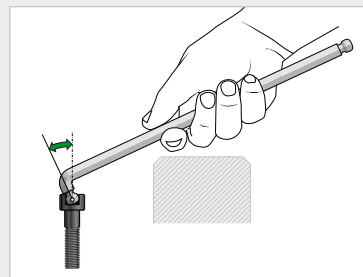
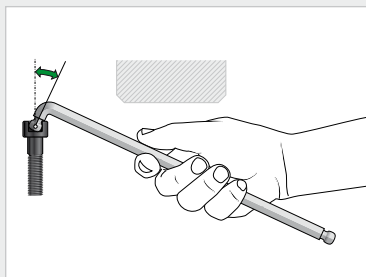
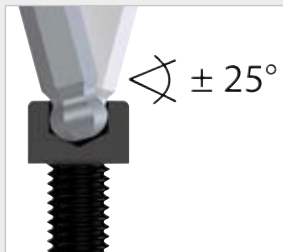

- Two ball ends and an extra short angle side for working optimally in confined spaces
- Positive or negative inclination produces a possible 50° angle of approach (+/- 25°) to the screw axis
- Projecting hindrances can be got round with the two ball ends - rapid work is the outcome
- The GEDORE vanadium steel 59CrV4 with its high manganese share ensures the screwdriver has that strength needed

H 42 DKEL-88

HEXAGON ALLEN KEY SET for in-hex screws, extra long, with double ball end

- Particularly suitable for confined spaces in view of a double ball end and short angled side
- Easy to use where normal hexagon allen keys would fail thanks to improved accessibility and a low profile
- Rapid progress in work since the two ball ends allow protrusions to be gone round
- Reduces the risk of injury to the fingers when working on flat surfaces
- GEDORE vanadium steel 59CrV4, zinc-plated

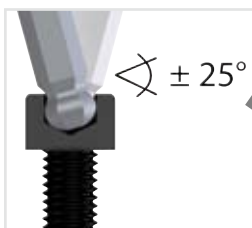

Contents	Weight	Code	No.
42 DKEL 2 2,5 3 4 5 6 8 10	0.400	2797186	H 42 DKEL-88

42 DKEL

HEXAGON ALLEN KEY for in-hex screws, extra long, with double ball end

- Particularly suitable for confined spaces in view of a double ball end and short angled side
- Easy to use where normal hexagon allen keys would fail thanks to improved accessibility and a low profile
- Rapid progress in work since the two ball ends allow protrusions to be gone round
- Reduces the risk of injury to the fingers when working on flat surfaces
- GEDORE vanadium steel 59CrV4, zinc-plated

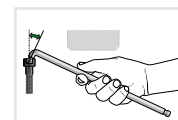
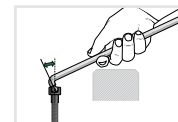
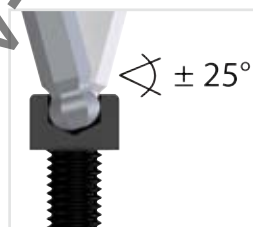

mm	L ₁	L ₂	Weight	Code	No.
1,5	89	7.5	0.003	2797062	42 DKEL 1,5
2	102	9.0	0.004	2797089	42 DKEL 2
2,5	115	10.0	0.006	2797097	42 DKEL 2,5
3	129	11.5	0.010	2797100	42 DKEL 3
4	144	14.5	0.018	2797119	42 DKEL 4
5	165	16.5	0.050	2797127	42 DKEL 5
6	186	19.0	0.060	2797135	42 DKEL 6
7	197	20.5	0.070	2797143	42 DKEL 7
8	205	22.0	0.090	2797151	42 DKEL 8
10	227	28.0	0.160	2797178	42 DKEL 10

H 42 KEL-88

HEXAGON ALLEN KEY SET for in-hex screws, extra long, with ball end

- In blue plastic holder (LPDE)
- GEDORE vanadium steel 59CrV4, chromated

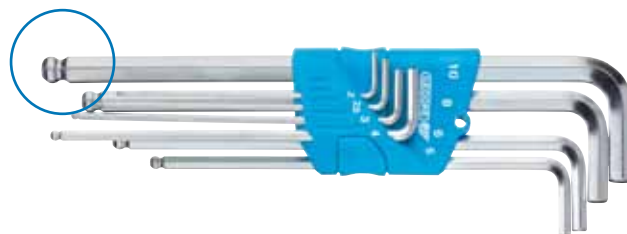
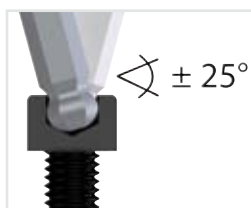

Contents	Weight	Code	No.
42 DKEL 2 2,5 3 4 5 6 8 10	0.415	1523988	H 42 KEL-88

**42 KEL****HEXAGON ALLEN KEY for in-hex screws, extra long, with ball end**

- GEDORE vanadium steel 59CrV4, chrome-plated

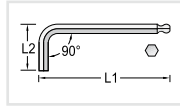
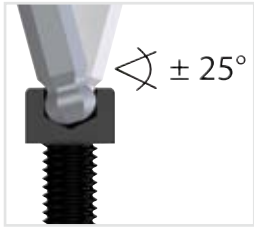

mm	L ₁	L ₂	kg	Code	No.
1,5	91.5	15.5	0.003	1563556	42 KEL 1,5
2	102.0	18.0	0.004	6370090	42 KEL 2
2,5	114.5	20.5	0.006	6370170	42 KEL 2,5
3	129.0	23.0	0.010	6370250	42 KEL 3
4	144.0	29.0	0.019	6370330	42 KEL 4
5	165.0	33.0	0.033	6370410	42 KEL 5
6	186.0	38.0	0.053	6370680	42 KEL 6
7	197.0	41.0	0.076	1729241	42 KEL 7
8	208.0	44.0	0.103	6370760	42 KEL 8
10	234.0	50.0	0.179	6370840	42 KEL 10
12	262.0	57.0	0.287	6370920	42 KEL 12

i Hexagon Allen Keys

- From GEDORE vanadium steel 61CrSiV5
- Self-designed/built machines from GEDORE's Special Machinery Construction section take up that precision-based manufacturing
- In a similar manner as with hot forging, the fibre course of the steel is not interrupted and thus retains its full strength, toughness and flexibility
- Professional tempering ensures a long service life
- Chamfered nose ends facilitate insertion into the screw head

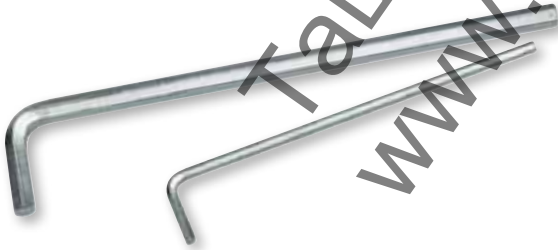
**H 42 EL-88****HEXAGON ALLEN KEY SET for in-hex screws, extra long**

- In blue plastic holder (LPDE)
- Acc. to DIN ISO 2936
- GEDORE vanadium steel 61CrSiV5, zinc-plated



Contents	kg	Code	No.
42 EL 2 2,5 3 4 5 6 8 10	0.425	1505416	H 42 EL-88

H 42 EL-88 A**HEXAGON ALLEN KEY SET for in-hex screws, extra long "AF"**

- In blue plastic holder (LPDE)
- GEDORE vanadium steel 61CrSiV5, zinc-plated

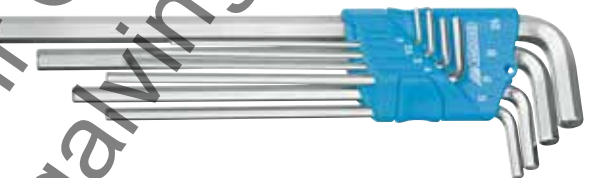

Contents	kg	Code	No.
42 EL 3/64 3/32 1/8 5/32 3/16 7/32 1/4 5/16"	0.300	1543555	H 42 EL-88 A

42 EL (MM)**HEXAGON ALLEN KEY for in-hex screws, extra long**

- Acc. to DIN ISO 2936
- GEDORE vanadium steel 61CrSiV5, zinc-plated

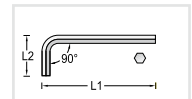

mm	L ₁	L ₂	kg	Code	No.
2	102.0	18.0	0.004	6350810	42 EL 2 (5/64AF)
2,5	114.5	20.5	0.007	6351030	42 EL 2,5
3	129.0	23.0	0.010	6351110	42 EL 3
4	144.0	29.0	0.019	6351380	42 EL 4
5	165.0	33.0	0.033	6351460	42 EL 5
5,5	186.0	38.0	0.047	1543342	42 EL 7/32AF (5,5MM)
6	186.0	38.0	0.054	6351540	42 EL 6
8	208.0	44.0	0.104	6351620	42 EL 8
10	234.0	50.0	0.184	6351700	42 EL 10
12	262.0	57.0	0.293	6351890	42 EL 12
14	294.0	70.0	0.453	6351970	42 EL 14





42 EL (AF)

HEXAGON ALLEN KEY for in-hex screws, extra long

- GEDORE vanadium steel 61CrSiV5, zinc-plated

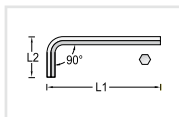

"AF"	L ₁	L ₂	kg	Code	No.
5/64	102.0	18.0	0.004	6350810	42 EL 2 (5/64AF)
3/32	114.5	20.5	0.006	1543377	42 EL 3/32AF
1/8	129.0	23.0	0.011	1543318	42 EL 1/8AF
5/32	144.0	29.0	0.019	1543326	42 EL 5/32AF
3/16	165.0	33.0	0.030	1543334	42 EL 3/16AF
7/32	186.0	38.0	0.047	1543342	42 EL 7/32AF (5,5MM)
1/4	197.0	41.0	0.065	1543369	42 EL 1/4AF
5/16	208.0	44.0	0.103	1543350	42 EL 5/16AF
3/8	234.0	50.0	0.167	1543385	42 EL 3/8AF
1/2	277.0	63.0	0.355	1543393	42 EL 1/2AF
9/16	294.0	70.0	0.475	1543407	42 EL 9/16AF

42 (MM)

HEXAGON ALLEN KEY SET for in-hex screws

- In blue PVC wallet
- GEDORE vanadium steel 61CrSiV5, zinc-plated



Contents	kg	Code	No.
2 2,5 3 4 5 6 8	0.144	6347510	42-07
2,5 3 4 5 6 8 10	0.254	6349050	42-70
3 4 5 6 8 10 12 14	0.716	6347780	42-08
2 2,5 3 4 5 6 7 8 10	0.297	6347860	42-09

42 (MM)

HEXAGON ALLEN KEY for in-hex screws

- Acc. to DIN ISO 2936
- GEDORE vanadium steel 61CrSiV5, zinc-plated up to size 12 mm, chrome-plated up from size 14 mm

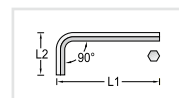

mm *	L ₁	L ₂	kg	Code	No.
0,7	33.0	7.0	0.001	6342200	42 0,7
0,9	33.0	11.0	0.001	6342390	42 0,9
1,3	41.0	13.0	0.001	6342470	42 1,3
1,5	46.5	15.5	0.001	6340260	42 1,5
2	52.0	18.0	0.002	6340340	42 2 (5/64AF)
2,5	58.5	20.5	0.004	6340420	42 2,5
3	66.0	23.0	0.006	6340500	42 3
4	74.0	29.0	0.011	6340690	42 4
5	85.0	33.0	0.019	6340770	42 5
5,5 *	82.0	32.0	0.022	6344840	42 7/32AF (5,5MM)
6	96.0	38.0	0.031	6340850	42 6
7 *	102.0	41.0	0.044	6340930	42 7
8	108.0	44.0	0.061	6341070	42 8
9 *	114.0	47.0	0.081	6341150	42 9
10	122.0	50.0	0.106	6341230	42 10
12	137.0	57.0	0.169	6341310	42 12
14	154.0	70.0	0.266	6341580	42 14
17	177.0	80.0	0.430	6341660	42 17
19	199.0	89.0	0.602	6341740	42 19
22	222.0	102.0	0.907	6341820	42 22
24	248.0	114.0	1.211	6341900	42 24
27	277.0	127.0	1.711	6342550	42 27
30	315.0	142.0	2.423	6342630	42 30
32	347.0	157.0	3.010	6342710	42 32

PH 42-88

HEXAGON ALLEN KEY SET for in-hex screws

- In blue plastic holder
- GEDORE vanadium steel 61CrSiV5, zinc-plated

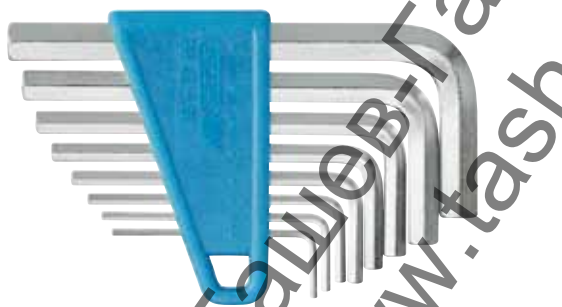

Contents	kg	Code	No.
42 2 2,5 3 4 5 6 8 10	0.245	6352000	PH 42-88

H 42-10

HEXAGON ALLEN KEY SET for in-hex screws

- In blue plastic holder (LPDE)
- Acc. to DIN ISO 2936
- GEDORE vanadium steel 61CrSiV5, zinc-plated



Contents	kg	Code	No.
42 1,3 1,5 2 2,5 3 4 5 6 8 10	0.259	1505408	H 42-10

**H 42-88 A****HEXAGON ALLEN KEY SET for in-hex screws**

- ▶ In blue plastic holder (LPDE)
- ▶ GEDORE vanadium steel 61CrSiV5, zinc-plated

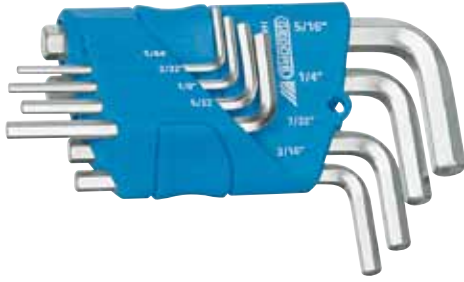

Contents		Code	No.
42 5/64 3/32 1/8 5/32 3/16 7/32 1/4 5/16"	0.172	1505424	H 42-88 A

42 (AF)**HEXAGON ALLEN KEY SET for in-hex screws**

- ▶ In blue PVC wallet
- ▶ GEDORE vanadium steel 61CrSiV5, zinc-plated



Contents		Code	No.
5/64 3/32 1/8 5/32 3/16 7/32 1/4"	0.103	6348750	42-07 A
1/8 5/32 3/16 1/4 5/16 3/8 1/2 9/16"	0.731	6348830	42-08 A
5/64 3/32 1/8 5/32 3/16 7/32 1/4 5/16 3/8"	0.257	6348910	42-09 A

42 (AF)**HEXAGON ALLEN KEY for in-hex screws**

- ▶ GEDORE vanadium steel 61CrSiV5, zinc-plated up to size 1/2", chrome-plated up from size 9/16"

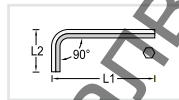

Hexagon Allen key	L ₁	L ₂		Code	No.
3/64	41.0	13.0	0.002	6342120	42 3/64AF
1/16	46.5	15.5	0.002	6342040	42 1/16AF
3/32	56.5	20.5	0.004	6344330	42 3/32AF
5/64	52.0	18.0	0.002	6340340	42 5/64AF
1/8	60.0	23.0	0.006	6344410	42 1/8AF
5/32	67.0	26.0	0.010	6344680	42 5/32AF
3/16	73.0	30.0	0.015	6344760	42 3/16AF
7/32	82.0	32.0	0.022	6344840	42 7/32AF (5,5MM)

Hexagon Allen key	L ₁	L ₂		Code	No.
1/4	92.0	36.5	0.035	6344920	42 1/4AF
5/16	102.0	43.0	0.059	6345060	42 5/16AF
3/8	115.0	49.0	0.094	6345140	42 3/8AF
1/2	142.0	61.0	0.205	6345220	42 1/2AF
9/16	154.0	66.0	0.274	6345300	42 9/16AF
5/8	168.0	76.0	0.376	6345490	42 5/8AF
3/4	199.0	89.0	0.309	6345570	42 3/4AF

S 42-07**HEXAGON ALLEN KEY SET for in-hex screws**

- ▶ On key ring with quick release
- ▶ GEDORE vanadium steel 61CrSiV5, zinc-plated

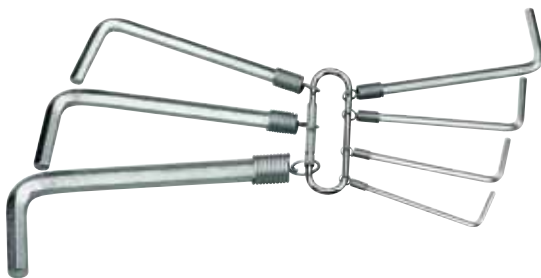

Contents		Code	No.
42 2,5 3 4 5 6 8	0.162	6347430	S 42-07

S 42-09 A**HEXAGON ALLEN KEY SET for in-hex screws**

- ▶ On key ring with quick release
- ▶ GEDORE vanadium steel 61CrSiV5, zinc-plated

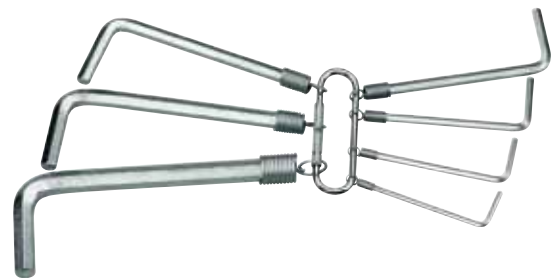

Contents		Code	No.
42 5/64 3/32 1/8 5/32 3/16 7/32 1/4 5/16 3/8"	0.273	6348160	S 42-09 A



42 Z

HEXAGON ALLEN KEY with pilot, for in-hex screws

- ▶ Acc. to DIN 6911
- ▶ Chrome-vanadium steel, zinc-plated
- ▶ * not standardised



mm *	L ₁	L ₂	kg	Code	No.
3	63	20	0.006	6342980	42 Z 3
4	70	25	0.010	6343010	42 Z 4
5	80	28	0.019	6343280	42 Z 5
6	90	32	0.031	6343360	42 Z 6
7	95	34	0.042	6343440	42 Z 7
8	100	36	0.058	6343520	42 Z 8
10	112	40	0.100	6343600	42 Z 10
12	125	45	0.162	6343790	42 Z 12
14	140	56	0.254	6343870	42 Z 14
17	160	63	0.418	6343950	42 Z 17
19	180	70	0.584	6344090	42 Z 19

SCL 42 K-70

HEXAGON ALLEN KEY SET for in-hex screws

- ▶ In robust metal clip
- ▶ Execution K with ball end
- ▶ GEDORE vanadium steel 61CrSiV5, zinc-plated

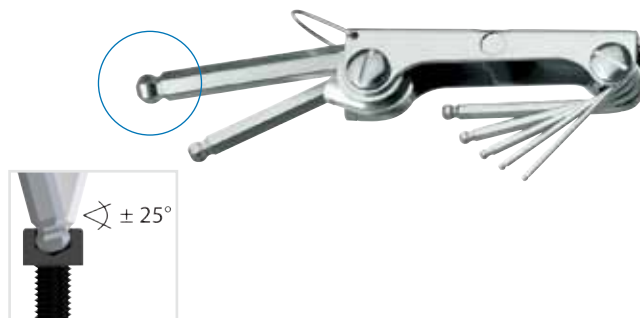

Contents	kg	Code	No.
2,5 3 4 5 6 8 10	0.361	6371140	SCL 42 K-70

42 X

CRANKED ALLEN SOCKET SCREW DRIVER for multi-point screws XZN

- ▶ Acc. to DIN 65253, tips acc. to DIN 2325
- ▶ GEDORE vanadium steel 50CrV4, chromated



M	L ₁	L ₂	kg	Code	No.
M 4	63	20	0.009	1531212	42 X 4
M 5	75	30	0.015	6350060	42 X 5
M 6	86	34	0.025	6350140	42 X 6
M 8	98	40	0.043	6350220	42 X 8
M 10	110	46	0.085	6350300	42 X 10
M 12	124	52	0.124	6350490	42 X 12
M 14	139	59	0.191	6350570	42 X 14
M 16	156	72	0.308	6350650	42 X 16
M 18	178	81	0.333	6350730	42 X 18

SCL 42-70

HEXAGON ALLEN KEY SET for in-hex screws

- ▶ In robust metal clip
- ▶ GEDORE vanadium steel 61CrSiV5, zinc-plated



Contents	kg	Code	No.
2,5 3 4 5 6 8 10	0.360	6347350	SCL 42-70

SCL 42-90 A

HEXAGON ALLEN KEY SET for in-hex screws

- ▶ In robust metal clip
- ▶ GEDORE vanadium steel 61CrSiV5, zinc-plated



Contents	kg	Code	No.
5/64 3/32 7/64 1/8 9/64 5/32 3/16 7/32 1/4"	0.260	6354800	SCL 42-90 A

SCL 43 TX-80

CRANKED SOCKET KEY SET for recessed TORX® screws

- ▶ In robust metal clip
- ▶ TORX® = reg. trademark of Acument Intellectual Properties, LLC. USA



Contents	kg	Code	No.
43 TX T9 T10 T15 T20 T25 T27 T30 T40	0.286	6346460	SCL 43 TX-80

43

CRANKED SOCKET KEY for multi-spline screws RIBE®

- ▶ GEDORE vanadium steel 50CrV4, chromated
- ▶ RIBE® = reg. trademark of Richard Bergner GmbH & Co. KG, Schwabach, Germany



M	L ₁	L ₂	kg	Code	No.
M5	71	25	0.016	6352270	43 5
M6	80	28	0.025	6352350	43 6
M8	90	32	0.049	6352430	43 8
M10	100	36	0.084	6352510	43 10
M12	112	40	0.135	6352780	43 12
M14	125	45	0.203	6352860	43 14

**H 43 TX****CRANKED SOCKET KEY SET for recessed TORX® screws**

- In blue LDPE holder
- Execution KTX with ball end
- Chrome-vanadium steel 50CrV4, gun-metal finish
- TORX® = reg. trademark of Acument Intellectual Properties, LLC. USA

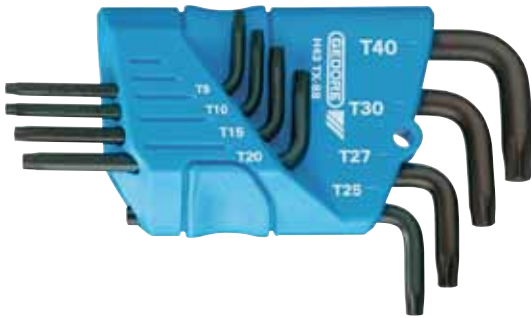

Contents		Code	No.
43 TX T7 T8 T9 T10 T15 T20 T25 T30 T40	0.120	1531417	H 43 TX-09
43 TX T9 T10 T15 T20 T25 T27 T30 T40	0.129	1531425	H 43 TX-88
43 TX T10 T15 T20 T25 T27 T30 T40 T45	0.168	1531433	H 43 TX-08

43 TX-09**CRANKED SOCKET KEY SET for recessed TORX® screws**

- In blue PVC wallet
- Chrome-vanadium steel 50CrV4, gun-metal finish
- TORX® = reg. trademark of Acument Intellectual Properties, LLC. USA



Contents		Code	No.
43 TX T7 T8 T9 T10 T15 T20 T25 T30 T40	0.115	6360960	43 TX-09

43 TX**CRANKED SOCKET KEY for recessed TORX® screws**

- Chrome-vanadium steel 50CrV4, gun-metal finish
- TORX® = reg. trademark of Acument Intellectual Properties, LLC. USA

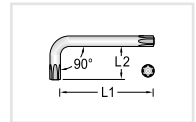

			L ₁	L ₂		Code	No.
T6	M2	1,69	42	16	0.003	6363550	43 TX T6
T7	M2,5	1,99	48	16	0.003	6363630	43 TX T7
T8	M2,5	2,31	48	16	0.004	6363710	43 TX T8
T9	M3	2,50	48	16	0.004	6363980	43 TX T9
T10	M3 - M3,5	2,74	51	17	0.005	6364010	43 TX T10
T15	M3,5 - M4	3,27	54	18	0.006	6364280	43 TX T15
T20	M4 - M5	3,86	57	19	0.008	6364360	43 TX T20
T25	M4,5 - M5	4,43	60	20	0.010	6364440	43 TX T25
T27	M4,5 - M6	4,99	64	21	0.016	6364520	43 TX T27
T30	M6 - M7	5,52	70	24	0.022	6364600	43 TX T30
T40	M7 - M8	6,65	76	26	0.031	6364790	43 TX T40
T45	M8 - M10	7,82	83	29	0.046	6364870	43 TX T45
T50	M10	8,83	95	32	0.060	6364950	43 TX T50
T55	M12	11,22	108	35	0.122	6365090	43 TX T55
T60	M14	13,25	120	38	0.187	6365170	43 TX T60





H 43 KTX-07

CRANKED SOCKET KEY SET for recessed TORX® screws

- ▶ In blue LDPE holder
- ▶ With ball end
- ▶ Chrome-vanadium steel 50CrV4, gun-metal finish
- ▶ TORX® = reg. trademark of Acument Intellectual Properties, LLC. USA



Contents		Code	No.
43 KTX T10 T15 T20 T25 T27 T30 T40	0.169	1531441	H 43 KTX-07

43 KTX

CRANKED SOCKET KEY for recessed TORX® screws, with ball end

- ▶ Working angle approx. 25°
- ▶ Chrome-vanadium steel, gun-metal finish
- ▶ TORX® = reg. trademark of Acument Intellectual Properties, LLC. USA



			L ₁	L ₂		Code	No.
T10	M3 - M3,5	2,74	73	17	0.006	6367110	43 KTX T10
T15	M3,5 - M4	3,27	83	17	0.009	6367380	43 KTX T15
T20	M4 - M5	3,86	94	18	0.012	6367460	43 KTX T20
T25	M4,5 - M5	4,43	96	18	0.015	6367540	43 KTX T25
T27	M4,5 - M6	4,99	106	20	0.024	6367620	43 KTX T27
T30	M6 - M7	5,52	119	24	0.033	6367700	43 KTX T30
T40	M7 - M8	6,65	132	28	0.049	6367890	43 KTX T40

708

TORX® GAUGE

- ▶ Easy identification of TORX® sizes, internal E4-E16, external T10-T60
- ▶ TORX® = reg. trademark of Acument Intellectual Properties, LLC. USA



Contents		Code	No.
E4 - E16	0.022	1394428	708
T10 - T60			

173

CRANKED SCREWDRIVER for slotted head screws

- ▶ Acc. to DIN 5208, blade tips acc. to DIN ISO 2380-2
- ▶ Chrome-vanadium steel, matt nickel-plated



mm	mm	mm		Code	No.
3.5	0.6	90	0.010	6437180	173 3,5
4.0	0.8	100	0.013	6437850	173 4
5.5	1.0	125	0.025	6436100	173 5,5
8.0	1.2	150	0.050	6436370	173 8
10.0	1.6	175	0.087	6437930	173 10
12.0	2.0	200	0.127	6436530	173 12

174

CRANKED SCREWDRIVER for cross-head screws PH

- ▶ Acc. to DIN 5208, tips acc. to DIN ISO 8764-1 PH
- ▶ Chrome-vanadium steel, matt nickel-plated



		mm		Code	No.
1-2	M2 - M5	100	0.029	6436880	174 1
3-4	M6 - M10	200	0.121	6436960	174 3



**VOLTAGE TESTER**

4610

CAR LIGHT TESTER

- For testing 6-24 Volt
- Compact brass model
- With cable and alligator crimp

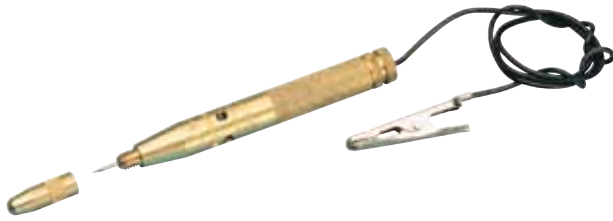

Measuring range			Code	No.
6-24 V	125	0.069	6698570	4610

4611

VOLTAGE TESTER

- For 6-24 Volt
- With cable and alligator crimp



mm				Code	No.
3.0	55	115	0.026	6698650	4611

→ 4615

540



→ V 4614 PLUS

540

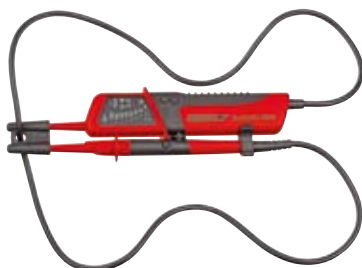
**VARIOUS**

149

MAGNETIZER AND DEMAGNETIZER

- Magnetizes or demagnetises screwdrivers, tweezers and similar tools made from steel
- Blue housing, made from high-quality plastic, unbreakable, cadmium-free



L	H	W		Code	No.
52	26	50	0.088	6416500	149

156 S

SQUARE BEADED AXLE

- Blue handle with hanging hole
- Blade bright nickel-plated

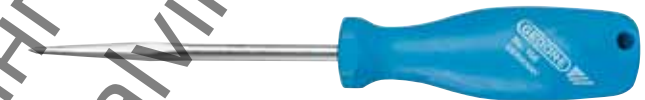

mm			Code	No.
100	200	0.084	6424520	156 S

→ 4612

612

**INDIVIDUAL ... CUSTOMISED FOR YOU!****Individual – precise – customised – flexible – right on!**

- From non-standard sizes, special surface treatment (colour and/or finish), customised tool modules through to special electronic product programming and establishing/implementing individual maintenance intervals (calibration/services) - and a lot more besides.
- **WE** develop special tools, customised tools and/or quality forgings **for YOU**.
- Your problems are our assignments.
- Simply contact us!

